

COMPACT A 12

TWO-WAY PROFESSIONAL SPEAKER

DESCRIPTION

COMPACT A 12 is a multipurpose two-way full-range professional speaker system, suitable for a wide range of applications, such as live sound reinforcement and stage monitoring as well as distributed sound systems for clubs or music venues. The combination of a 1.75" compression driver, 12" woofer, and the constant directivity True Resistive Waveguide produces coherent 100° x 60° coverage for the listening area with high SPL, distortion-free sound. The sleek and lightweight cabinet uses a special polypropylene composite material with an M-brace internal reinforcement, making it easy to carry and secure to install on a pole, flown-, wall-, or truss-mounted using the multiple rigging points and available accessories.



FEATURES

- 400 W power handling
- Up to 129 dB Sound Pressure Level
- 55-20000 Hz linear frequency response
- 1.75" Compression Driver
- 12" High Power Woofer
- Robust composite material cabinet
- Steel full front grille
- Optional mounting accessories
- 2 x SPEAKON connectors

TECHNICAL SPECIFICATIONS

Acoustical specifications	Frequency Response (-10dB):	55 Hz ÷ 20000 Hz
	Max SPL @ 1m:	129 dB
	Horizontal coverage angle:	100°
	Vertical coverage angle:	60°
	System Sensitivity:	97 dB
Power section	Amplification:	Full Range
	Nominal Impedance:	8 ohm
	Power Handling:	400 W
	Peak Power Handling:	1600 W PEAK
	Recommended Amplifier:	800 W
	Protections:	Dynamic Active Mosfet
	Crossover Frequencies:	1200 Hz
Transducers	Compression Driver:	1.0", 1.75" v.c
	Woofers:	12", 2.5" v.c
Input/Output section	Input connectors:	Speakon
	Output connectors:	Speakon
Standard compliance	CE marking:	Yes
Physical specifications	Cabinet/Case Material:	PP Composite
	Hardware:	1 x M10 top, 1 x M10 each side
	Handles:	1 top , 1 each side
	Pole mount/Cap:	Yes
	Grille:	Steel
	Color:	Black
Size	Height:	641.6 mm / 25.26 inches
	Width:	369.9 mm / 14.56 inches
	Depth:	363 mm / 14.29 inches
	Weight:	18.2 kg / 40.12 lbs
Shipping informations	Package Height:	685 mm / 26.97 inches
	Package Width:	430 mm / 16.93 inches
	Package Depth:	423 mm / 16.65 inches
	Package Weight:	20.2 kg / 44.53 lbs

PART NUMBER

- **13000739**

COMPACT A 12

EAN 8024530019754

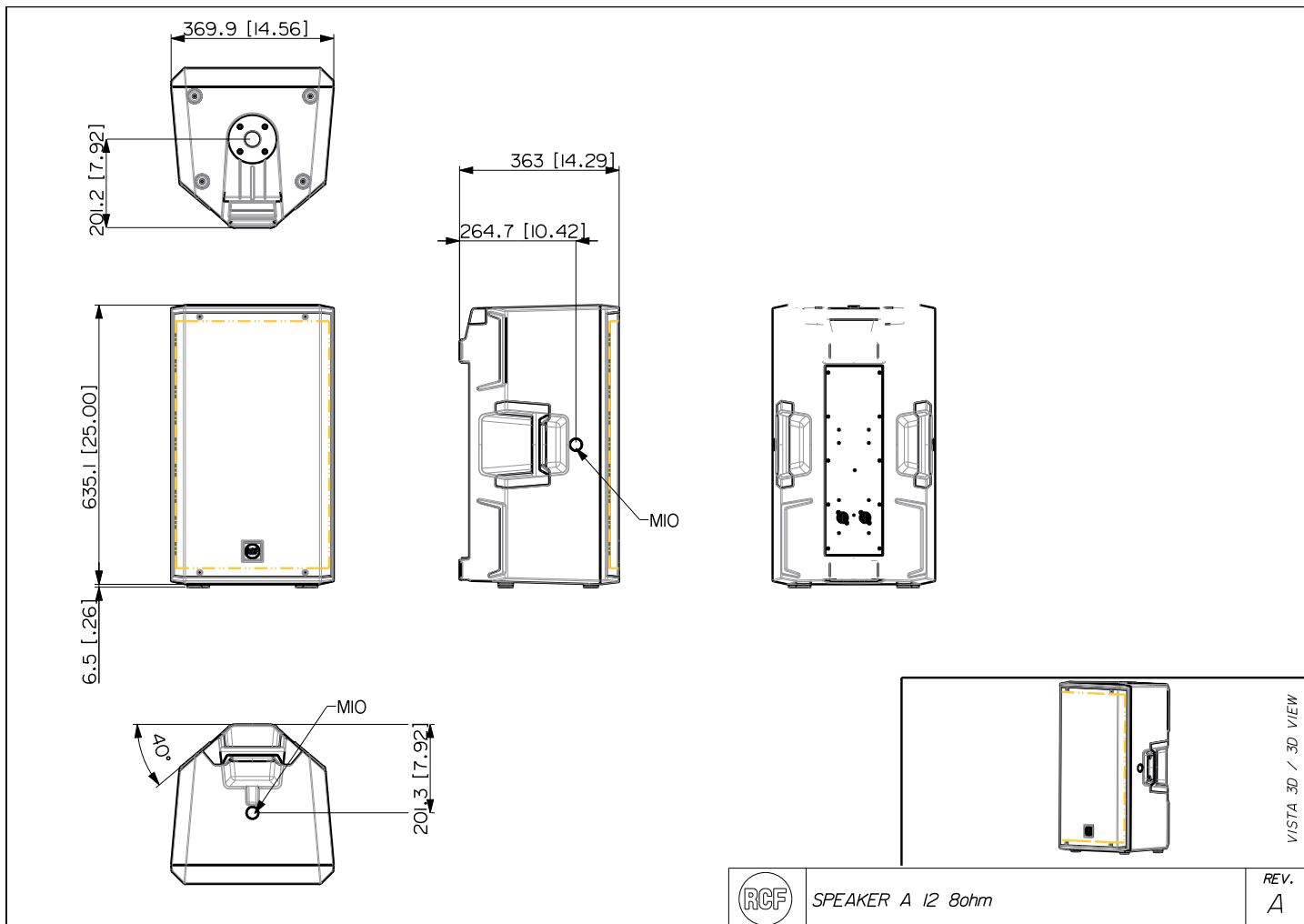

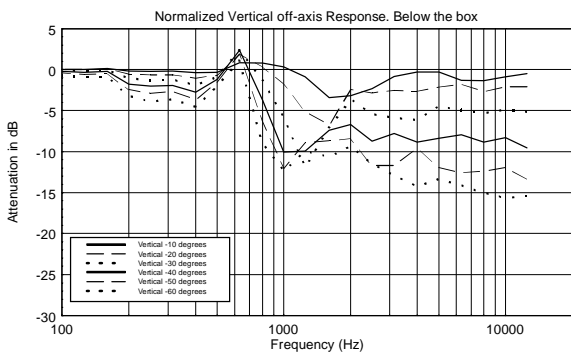
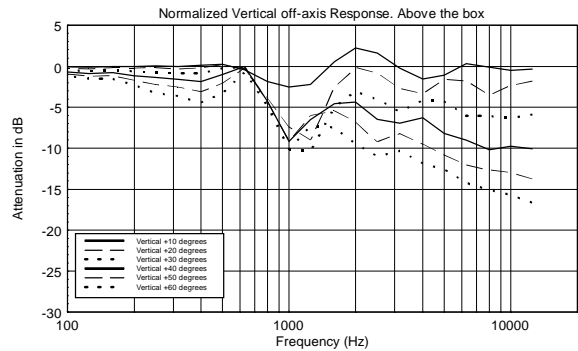
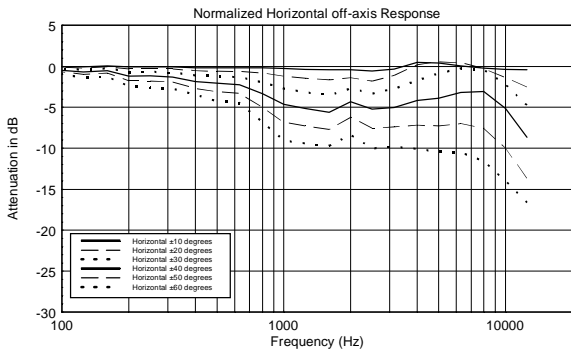
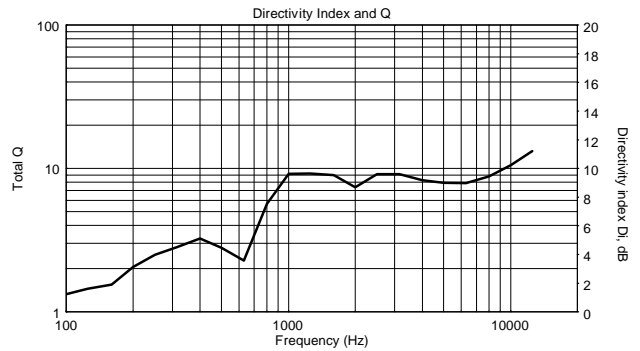
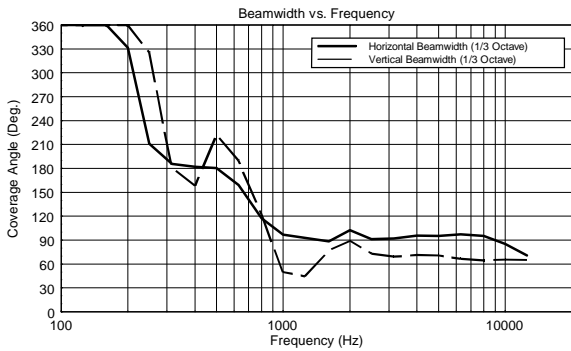
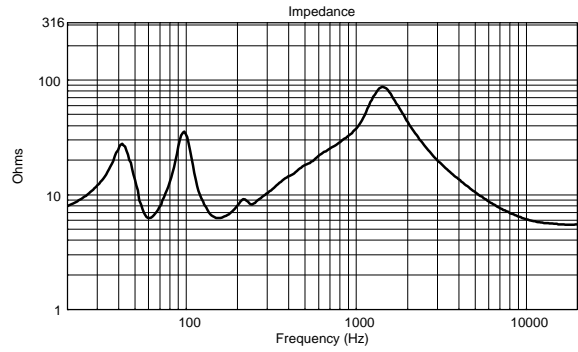
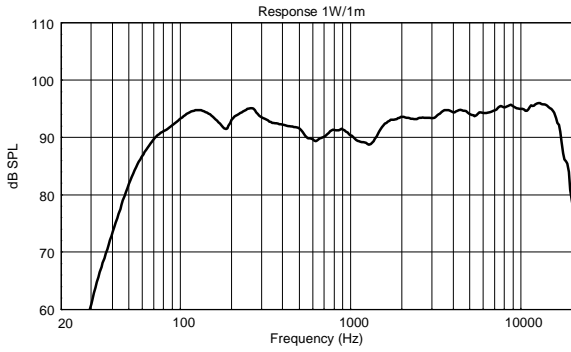

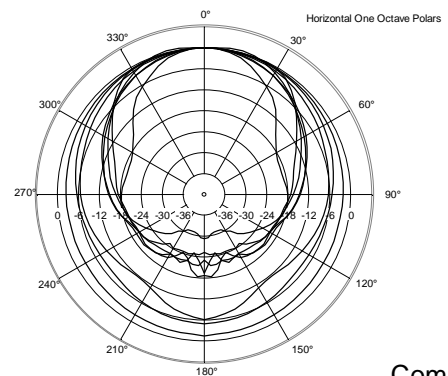
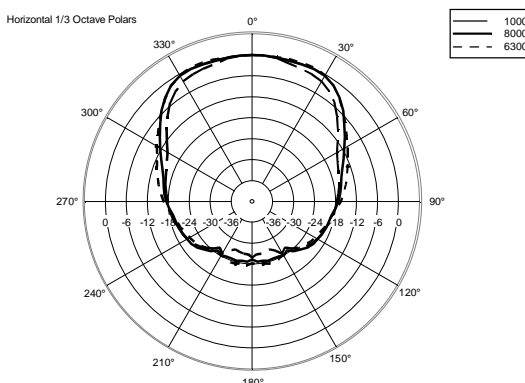
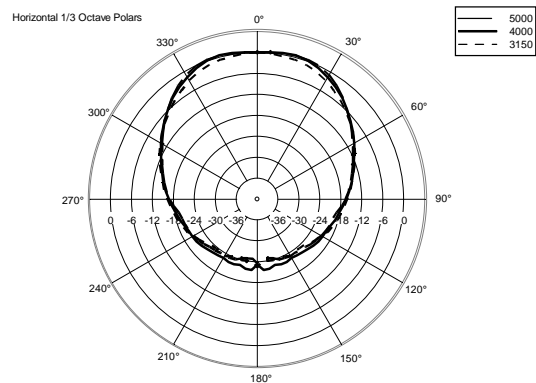
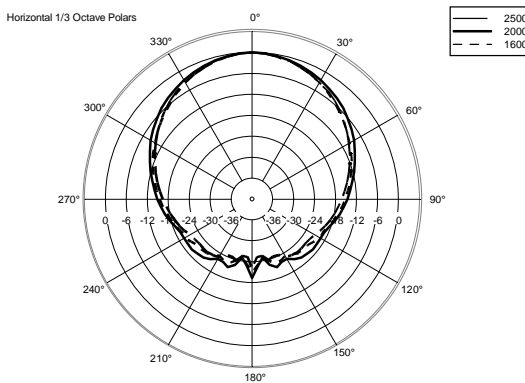
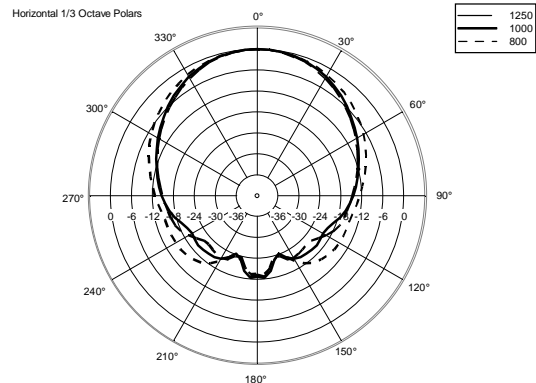
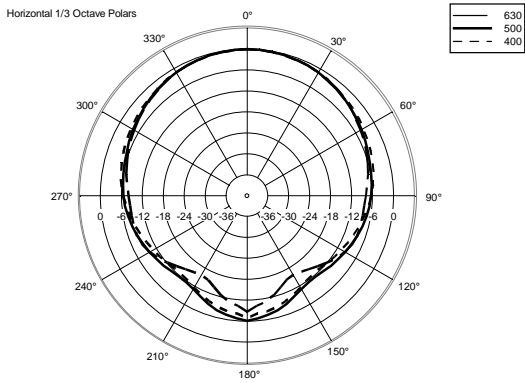
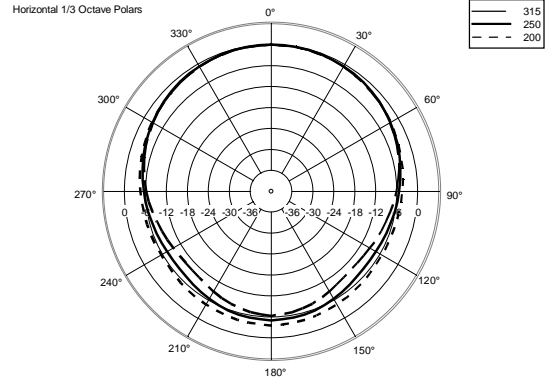
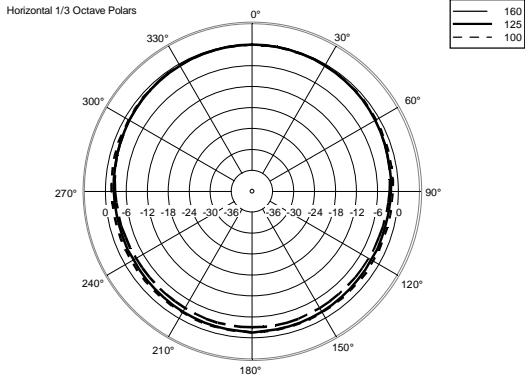

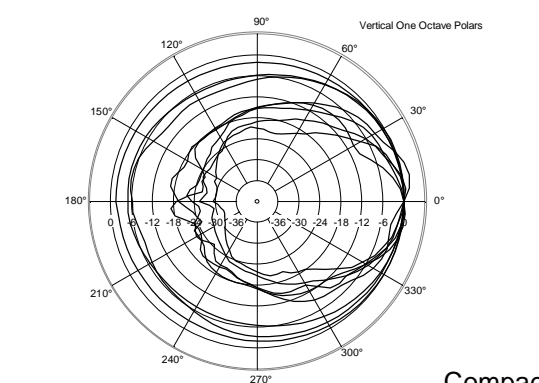
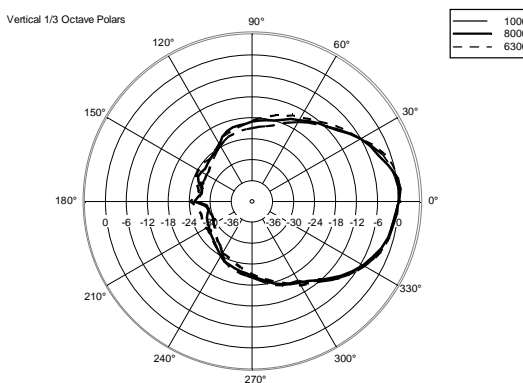
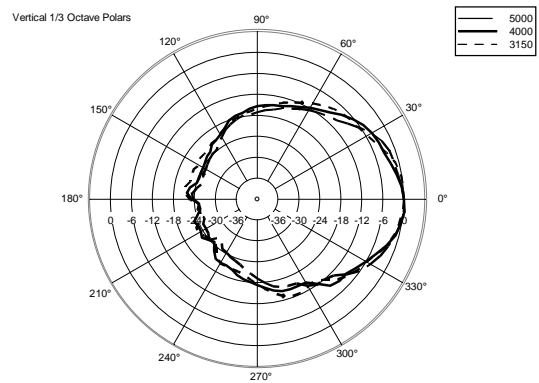
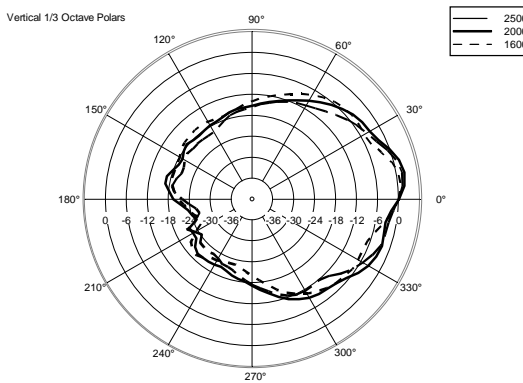
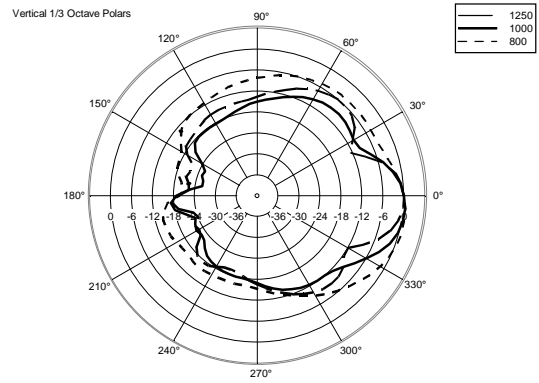
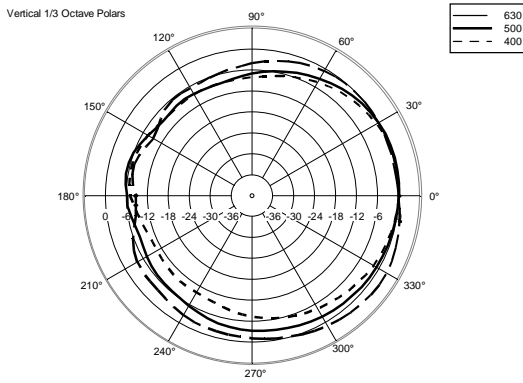
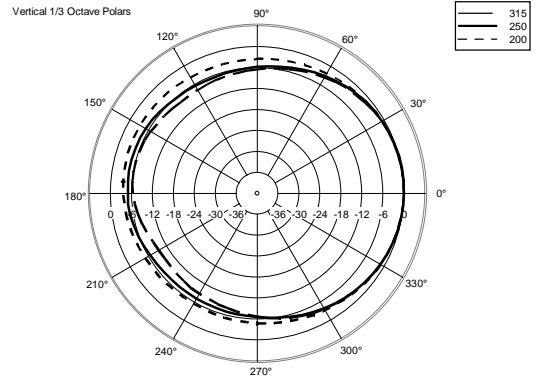
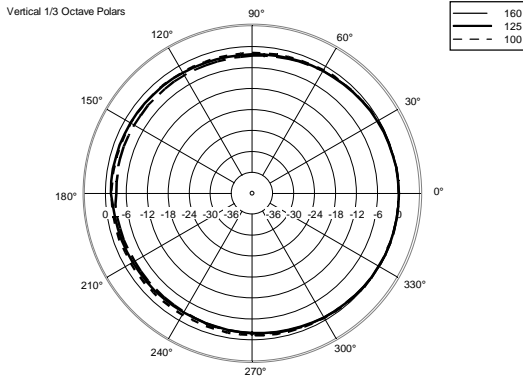









ACCESSORIES

	AC PMA - POLE MOUNT	PART NUMBER EAN:	13360034 8024530007713
	AC PM-M20	PART NUMBER EAN:	13360067 8024530014599
	AC PMX POLE MOUNT M20	PART NUMBER EAN:	13360232 8024530010058
	AC PRO-FS PROFESS. LOCKING FLOOR STAND	PART NUMBER EAN:	13360109 8024530006471
	AC PRO-PM PROFESS. LOCKING POLE MOUNT	PART NUMBER EAN:	13360110 8024530006488
	COVER CVR ART 912	PART NUMBER EAN:	13360474 8024530018849
	FLYING BRACKET FL-BR ART 912	PART NUMBER EAN:	13360477 8024530019204
	HORIZONTAL BRACKET H-BR ART 912	PART NUMBER EAN:	13360475 8024530019228
	VERTICAL BRACKET V-BR ART 912	PART NUMBER EAN:	13360476 8024530019211



A&E SPECIFICATIONS

The product shall be a multipurpose two-way full-range professional speaker system, suitable for a wide range of applications, such as live sound reinforcement and stage monitoring as well as distributed sound systems for clubs or music venues. It shall feature high sensitivity, typical of professional audio cabinets, with smooth and wide frequency response, thanks to the wave-guided compression driver. It shall be robust, suitable for transportation and for any working environment. Optional mounting accessories shall be available for wall or ceiling installations.